

| 構成内容 / Components | | | | |
|-------------------|---------------------------|----------|---------------------------------------|--|
| No. | 名称 / Part name | 数量 / Pcs | 材質 / Material | 色・表面処理 / Color・Finish |
| 1 | パネル / End panel | 2 | アルミ板 / Aluminium A1050P | ブラック, シルバー・アルマイト / Black, Silver・anodized |
| 2 | 上カバー / Top cover | 1 | アルミ押出材 / Extruded aluminium A6063S-T5 | ブラック, シルバー・アルマイト & クリア塗装 / Black, Silver・anodized & clear coated |
| 3 | 下カバー / Bottom cover | 1 | アルミ押出材 / Extruded aluminium A6063S-T5 | ブラック, シルバー・アルマイト & クリア塗装 / Black, Silver・anodized & clear coated |
| 4 | 取付ビス(六角穴付皿 M5×10) / Screw | 8 | ステンレス / Stainless steel | 無処理 / Unfinished |
| 5 | ゴム足 / Rubber feet | 4 | 合成ゴム / Rubber | ブラック / Black |

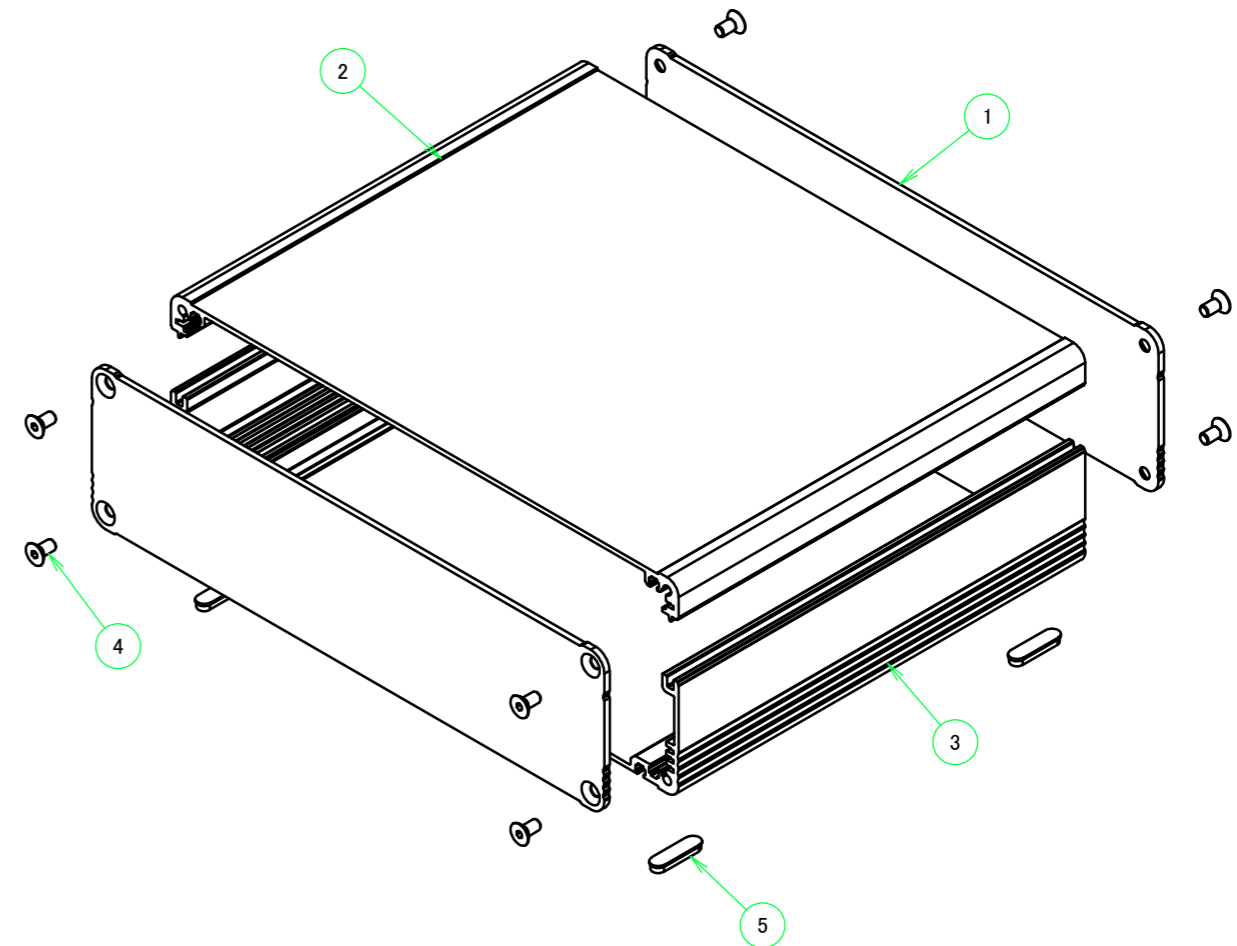

※ゴム足は任意の場所に貼り付けできます。

※Adhesive rubber feet included.

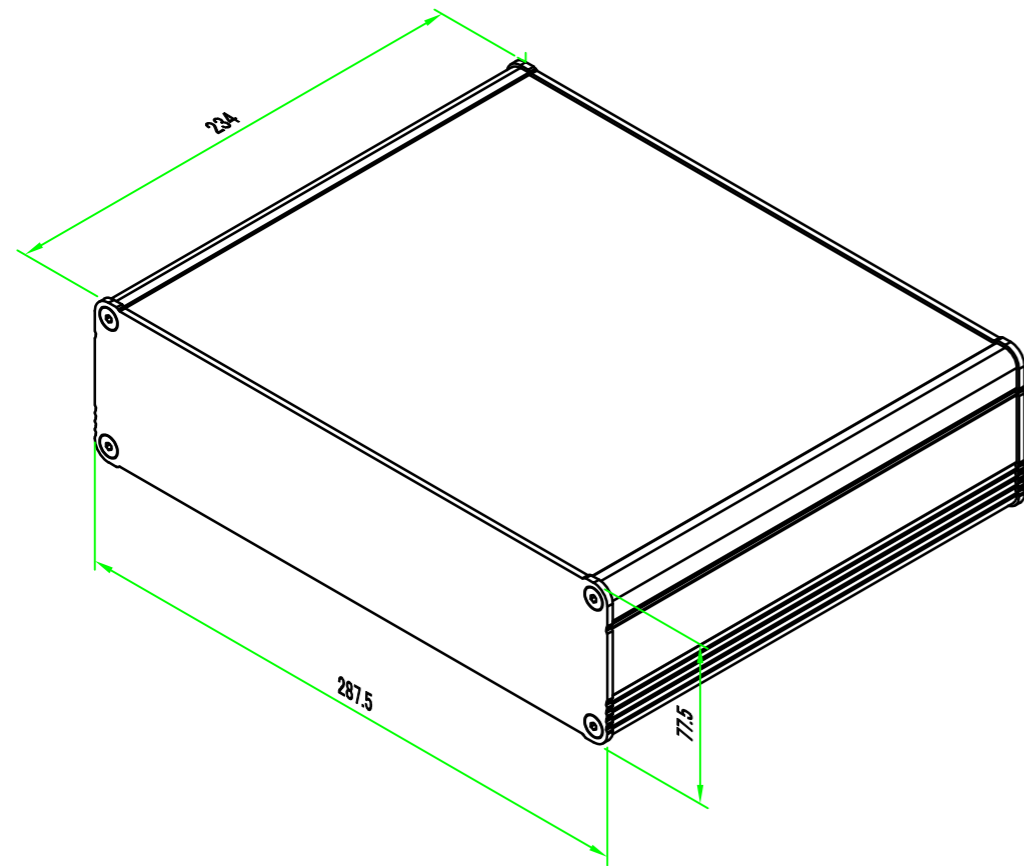

本図面および付帯する部品図の著作権は株式会社タカチ電機工業に帰属します。 / Copyright (C) TAKACHI ELECTRONICS ENCLOSURE CO., LTD. All Rights Reserved.

| 色仕様(型番末尾口) / Color type | | |
|-------------------------|---------------|---------------|
| 記号 / Code | 上下カバー / Cover | パネル / Panel |
| SS | シルバー / Silver | シルバー / Silver |
| SB | シルバー / Silver | ブラック / Black |
| BS | ブラック / Black | シルバー / Silver |
| BB | ブラック / Black | ブラック / Black |

| | | | | |
|---|--------------------|--------------------|---|--|
|  株式会社タカチ電機工業 TAKACHI ELECTRONICS ENCLOSURE CO., LTD. | | | 品名 / Title アルミ押出材ケース EXTRUDED ALUMINIUM CASE |  尺度 / Scale 1 : 3 |
| 承認 / Approved 中根 | 検図 / Checked 大江 | 製図 / Created 岡本 | 型番 / Product number EX29-8-23□□ 作成日 / Date 2022/11/22 | |

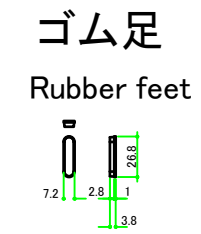
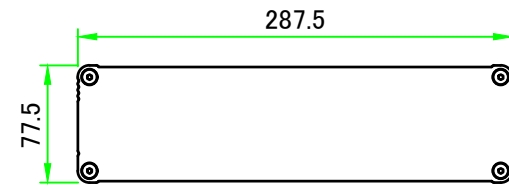

B-B (1:5)

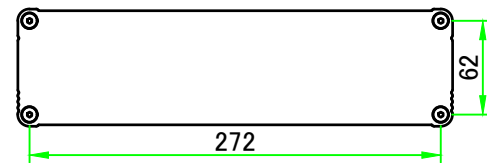
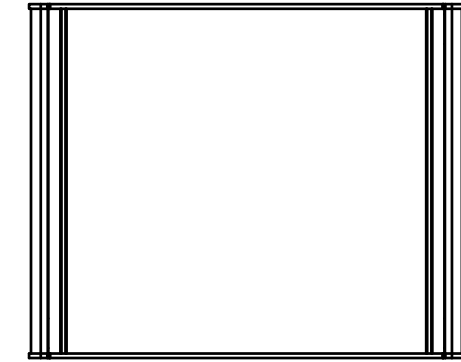
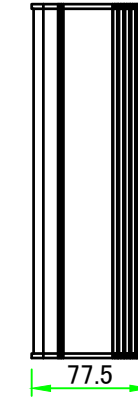
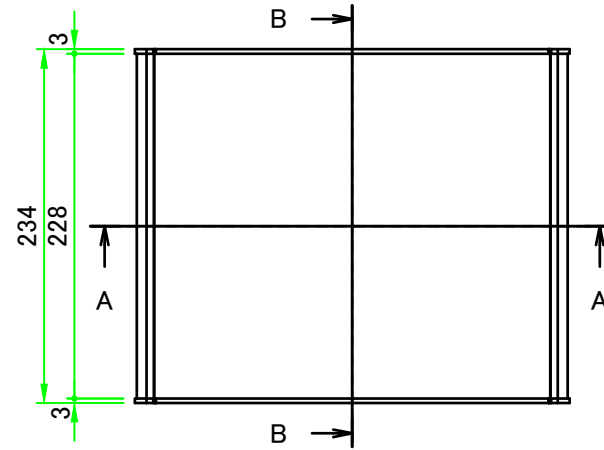
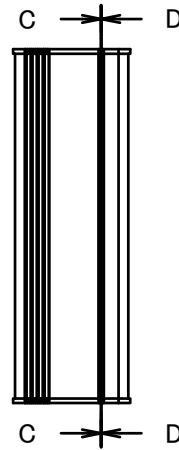
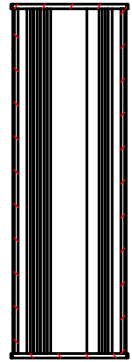

C-C (1:5)

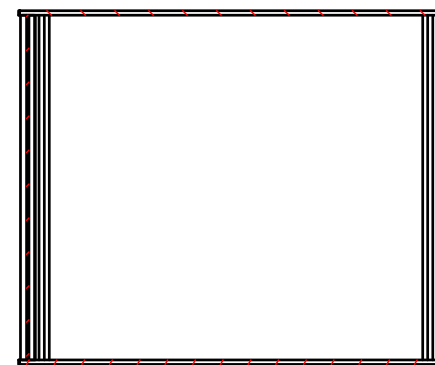

D-D (1:5)

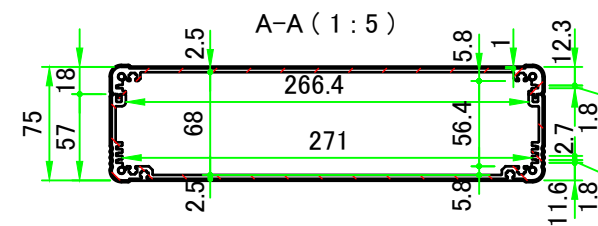
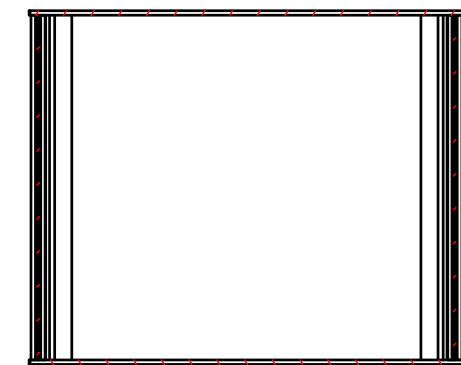

| | | | | |
|---|------------------|------------------|---|-------------------|
| 株式会社タカチ電機工業 TAKACHI ELECTRONICS ENCLOSURE CO., LTD. | | | 品名/Title アルミ押出材ケース EXTRUDED ALUMINIUM CASE | 尺度/Scale 1 : 5 |
| 承認/Approved 中根 | 検図/Checked 大江 | 製図/Created 岡本 | 型番/Product number EX29-8-23□□ | |
| | | | 作成日/Date 2022/04/01 | 2 / 5 |

上カバー / Top cover

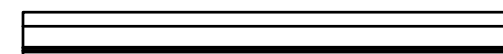
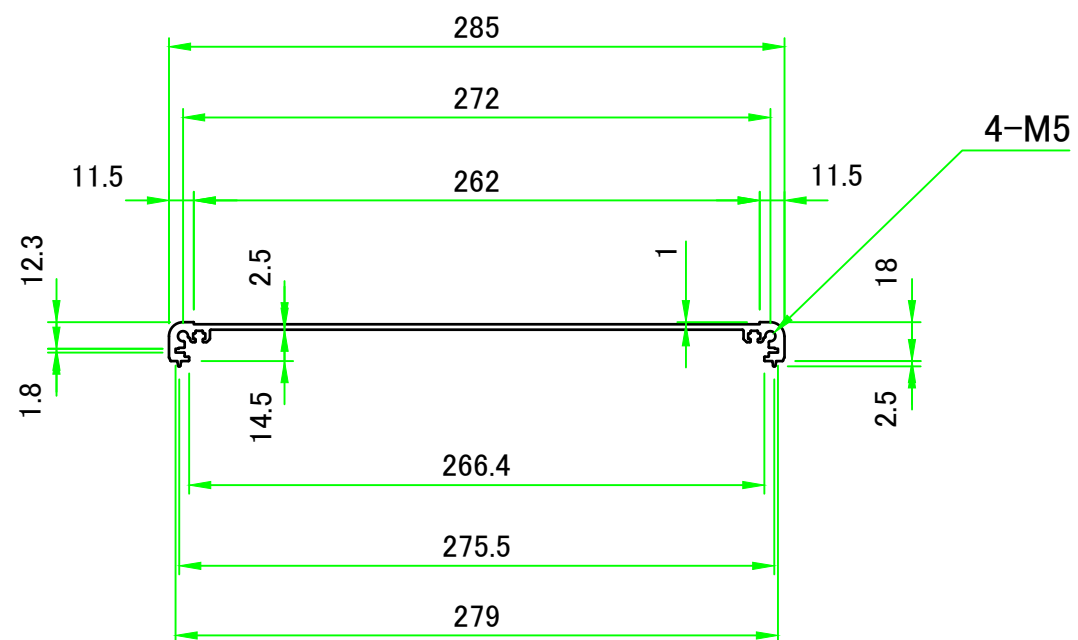
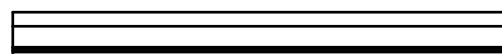
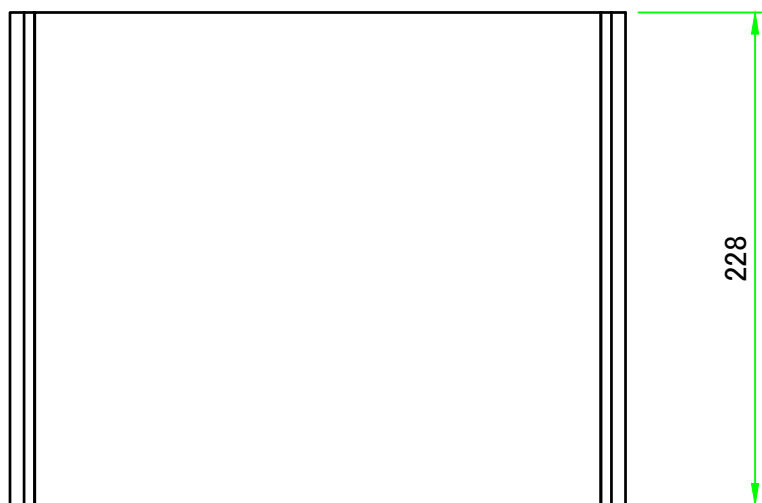

| | | | | |
|--|------------|------------|--------------------------------|--|
|  株式会社タカチ電機工業 TAKACHI ELECTRONICS ENCLOSURE CO., LTD. | | | 品名/Title 上カバー TOP COVER |  尺度/Scale 1: 3.5 |
| 承認/Approved | 検図/Checked | 製図/Created | 型番/Product number W285-D228 | |
| 中根 | 岡本 | 大江 | 作成日/Date 2021/07/13 | 3 / 5 |

下カバー / Bottom cover

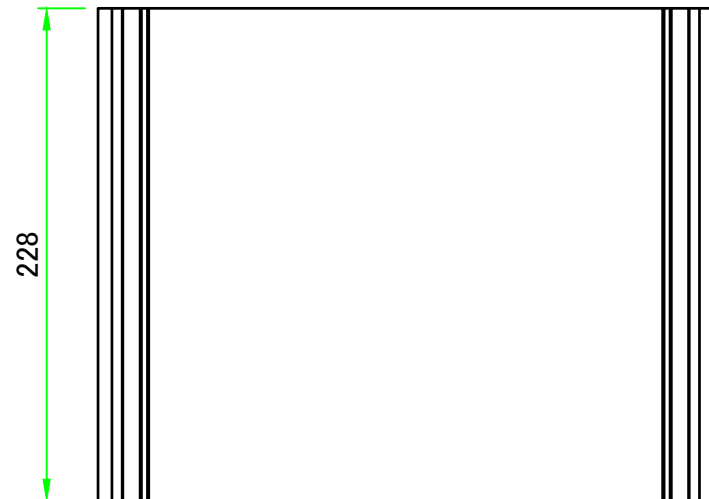
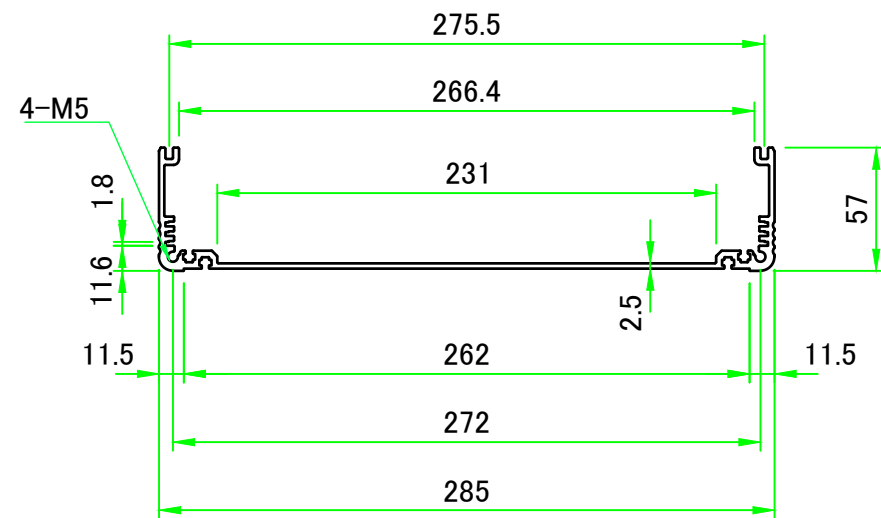
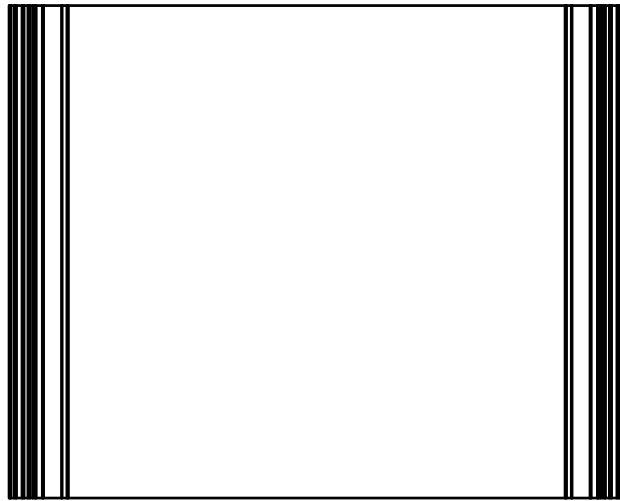

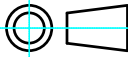
| | | | | |
|--|------------|------------|------------------------------------|---|
|  株式会社タカチ電機工業 TAKACHI ELECTRONICS ENCLOSURE CO., LTD. | | | 品名/Title 下カバー BOTTOM COVER |  尺度/Scale 1:3.5 |
| 承認/Approved | 検図/Checked | 製図/Created | 型番/Product number W285-H75-D228 | |
| 中根 | 岡本 | 大江 | 作成日/Date 2021/07/08 | 4 / 5 |

パネル / End panel

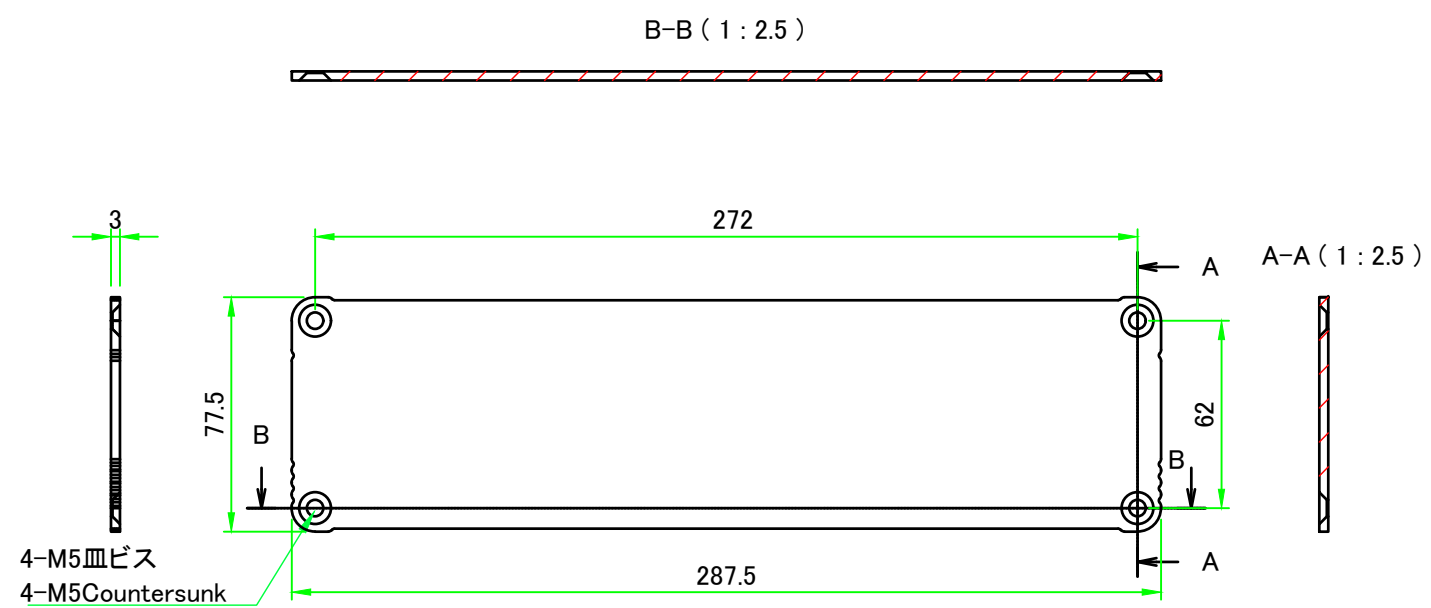

表面 / Outside

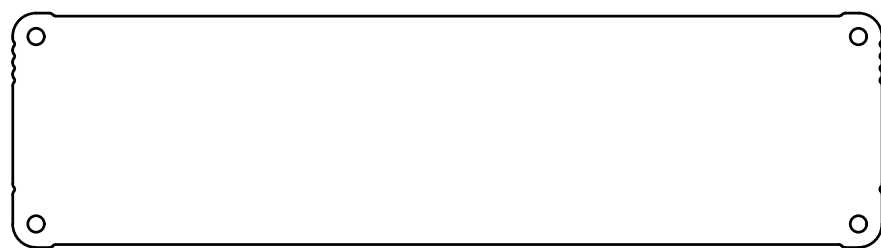

裏面 / Inside

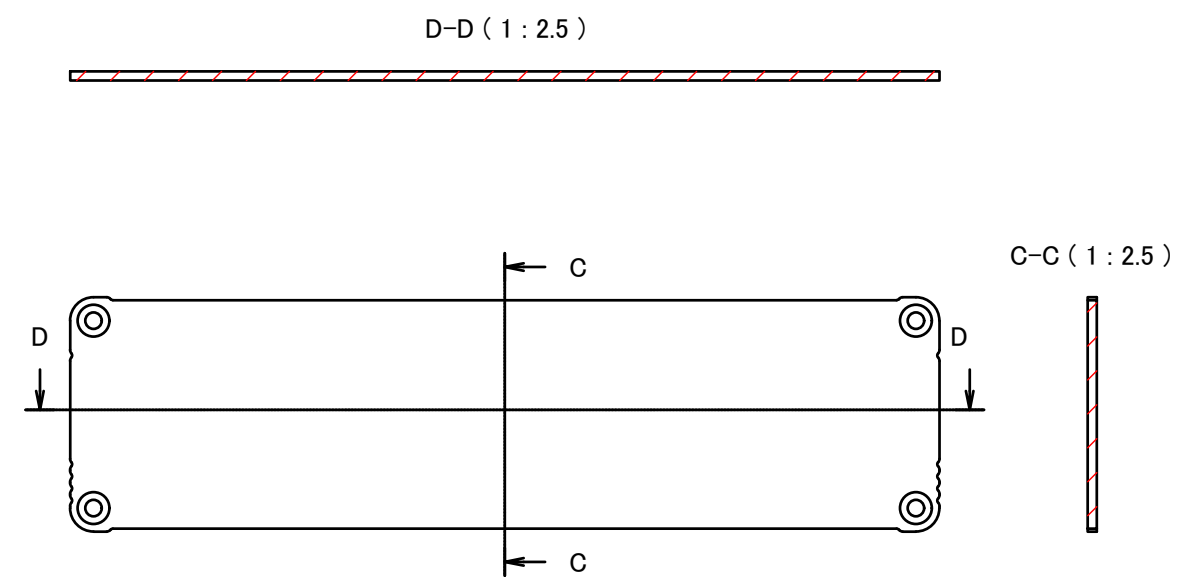

表面 / Outside

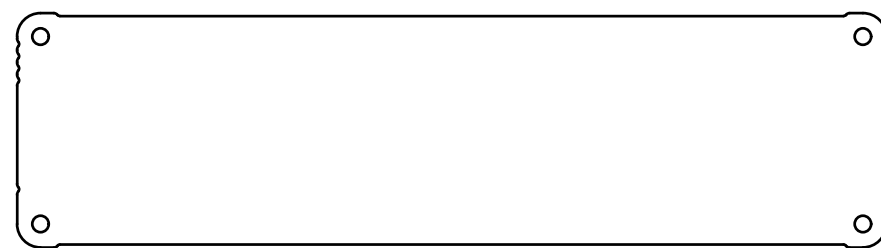

裏面 / Inside

| | | | | |
|--|------------|------------|--|-------------------|
| 株式会社タカチ電機工業 <small>TAKACHI ELECTRONICS ENCLOSURE CO., LTD.</small> | | | 品名/Title アルミ押出材ケース EXTRUDED ALUMINIUM CASE | 尺度/Scale 1:2.5 |
| 承認/Approved | 検図/Checked | 製図/Created | 型番/Product number EX29-8-〇□□ | |
| 中根 | 大江 | 岡本 | 作成日/Date 2022/04/01 | 5 / 5 |